

Effect of Mixture Concentration Inhomogeneity on Detonation Properties in Pressure Gain Combustors

FE0025525

PI: Domenic Santavicca
Co-PIs: Richard Yetter and Stephen Peluso

UTSR 2017 Workshop
November 2, 2017

Center for Combustion, Power, and Propulsion
Mechanical and Nuclear Engineering
Penn State University

Rotary detonation engine issues and the importance of inhomogeneity

Although a promising technology, several key issues must be addressed before rotary detonation engines can be implemented for power generation, including:

- 1) Measuring and controlling CO and NO_x emissions
- 2) Reactant injection and reducing reverse flow
- 3) High local heat fluxes within the combustor
- 4) Quantifying actual pressure gain
- 5) Fuel-oxidizer mixing
- 6) Detonation-mixture inhomogeneity interaction

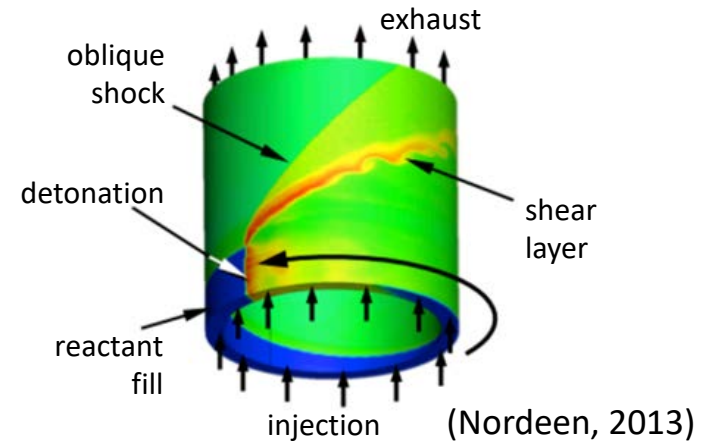

In a summary of the extensive RDE work completed at the Lavrent'ev Institute of Hydrodynamics, Bykovskii et al. (2006) concluded that “[t]he **governing factor** in obtaining an **effective continuous detonation regime** belongs to **mixing** in the region of transverse detonation wave propagation.”

RDE schematics and geometric influences on mixing

RDE illustration

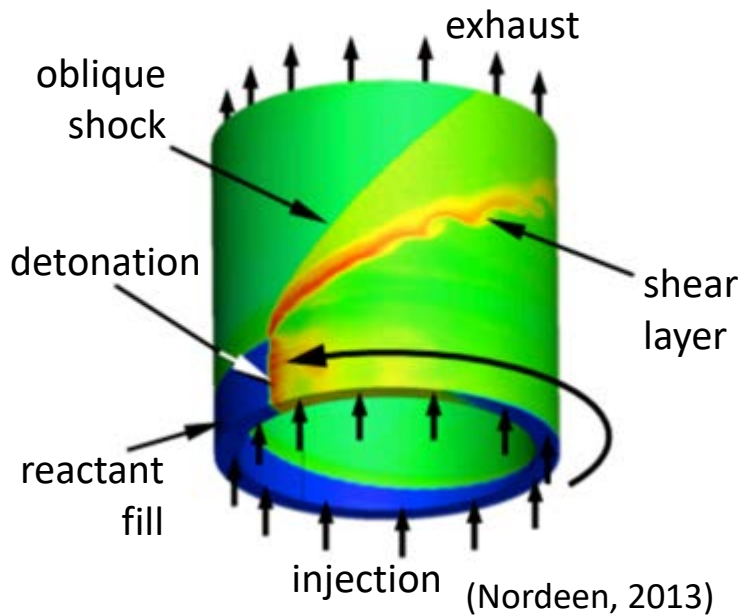

RDE flow schematic

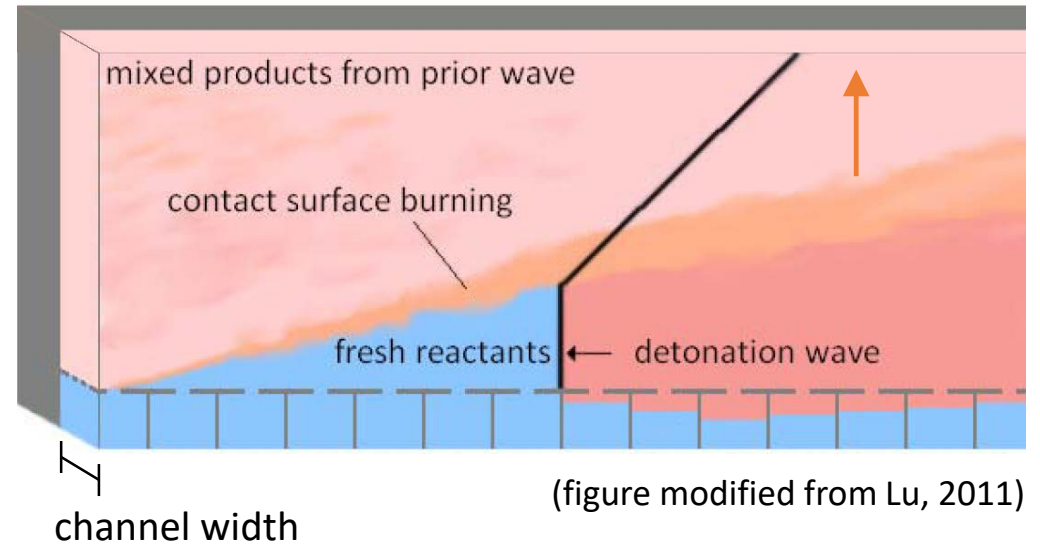

- RDEs are especially prone to spatial variations in mixture concentration due to:
 - Short mixing times (0.05 to 1 msec), since the combustor mixture region must refill before the detonation wave passes the injector holes again
 - Time-varying reactant flow rates due to changes in pressure downstream of the injection holes as the detonation wave passes

Previous studies on detonation-inhomogeneity interaction

Author	Year	Experimental or Numerical	Perpendicular or Parallel	Mixture	Description
Mikhalkin	1996	N	N/A	C ₂ H ₄ -O ₂ CH ₄ -O ₂	Regions of poorly mixed gases have a similar effect as inert diluents on detonation properties
Kuznetsov	1998	E	=	H ₂ -Air	Strong mixture concentration gradients dampen detonation propagation
Brophy	2006	E	⊥	C ₂ H ₄ -Air	Fuel distribution effects in a PDE
Bykovskii	2006	E	⊥	Various mixtures	Summary of RDE experiments highlighted the effects of poor mixing on operation
Ishii	2007	E	⊥	H ₂ -O ₂ H ₂ -O ₂ -N ₂	Deflection of detonation wave, skewing of cell structure and changes in detonation velocity
Kessler	2012	N	=	CH ₄ -Air	Shock wave-combustion zone decoupling led to turbulent deflagration
Ettner	2013	N	⊥	H ₂ -O ₂	Concentration gradient effected on detonation cell shape, instability, and pressure distribution
Nordeen	2013	N	⊥	H ₂ -Air	Simulation of an RDE with variable mixedness
Driscoll	2015	N	N/A	H ₂ -Air	Simulation of mixing in a RDE

Previous studies on detonation-inhomogeneity interaction

- Majority of experimental studies relied on diffusion to produce concentration gradients

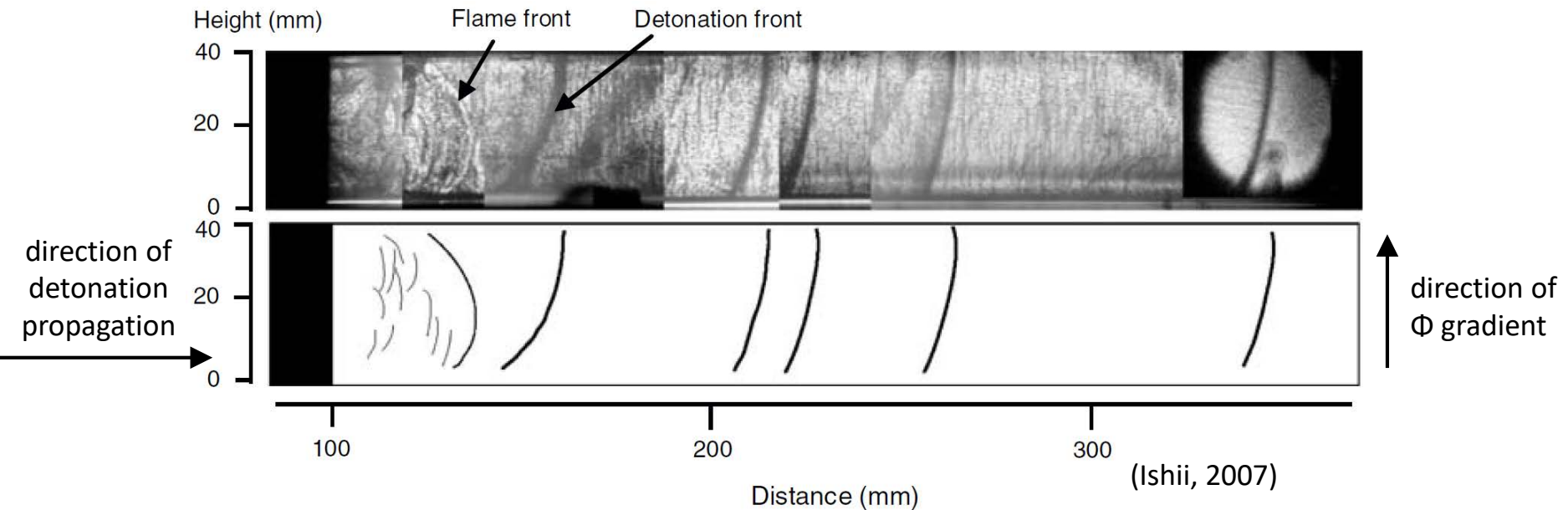

- For example, Ishii (2007) showed that concentration gradients can “skew” the leading detonation wave, resulting in irregular cell structures and a reduction in wave velocity
- Other studies have shown that inhomogeneity can result in shock waves decoupling from the combustion zone (resulting in turbulent deflagrations), a reduction or an increase in peak detonation pressure, and changes in mixture failure limits

Project Objectives

In order to improve current rotary detonation engine designs to produce practical devices, the effect of concentration inhomogeneity on detonation properties will be determined.

The main objectives of this project are to:

- 1) determine the degree of fuel-oxidizer mixture concentration inhomogeneity in a rotary detonation engine
- 2) experimentally study the effects of inhomogeneity on detonation wave quality and stability (i.e., wave speed, planar vs non-planar, wave height, etc.)
- 3) perform a parametric study to better understand the relationships between combustor geometries and fuel/oxidizer injection.

General technical approach

- In order to increase measurement access, an “unwrapped” RDE will be tested in this study:

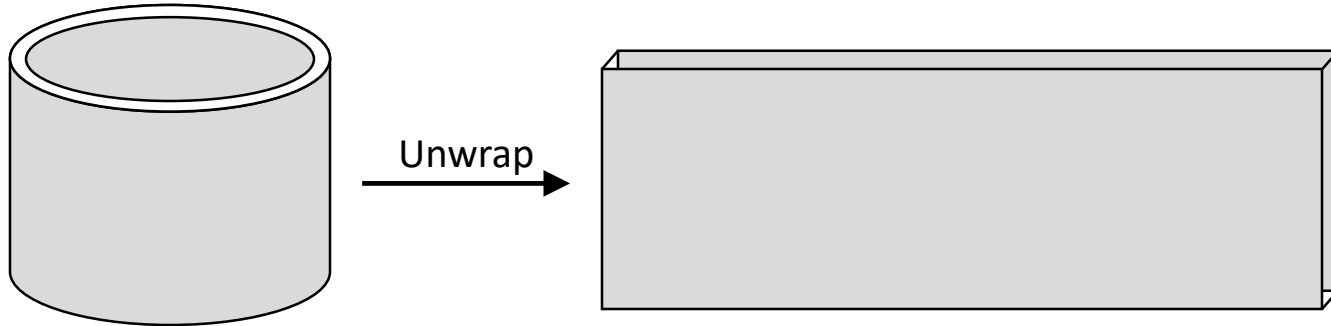

- Two configurations (parallel and perpendicular) will also be tested

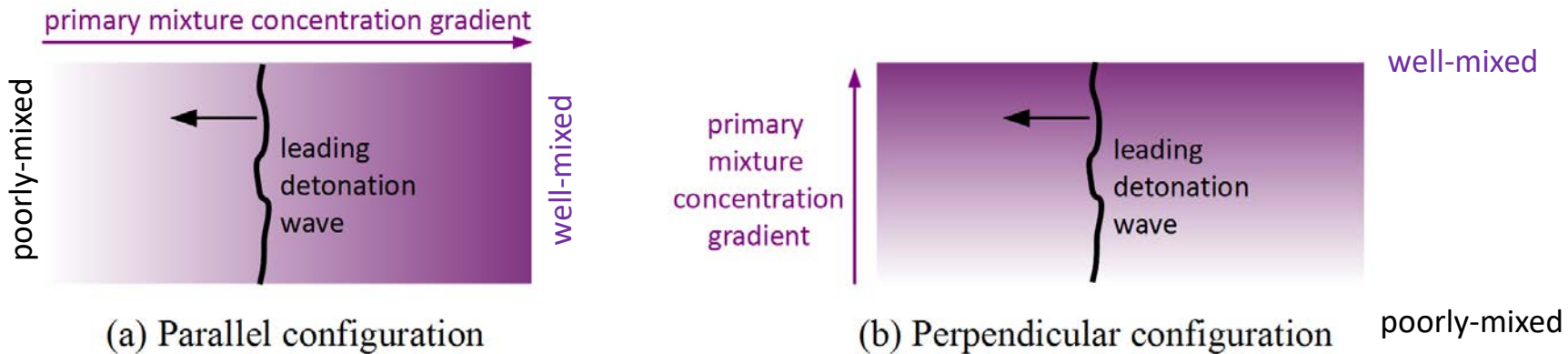

Overview of detonation facility

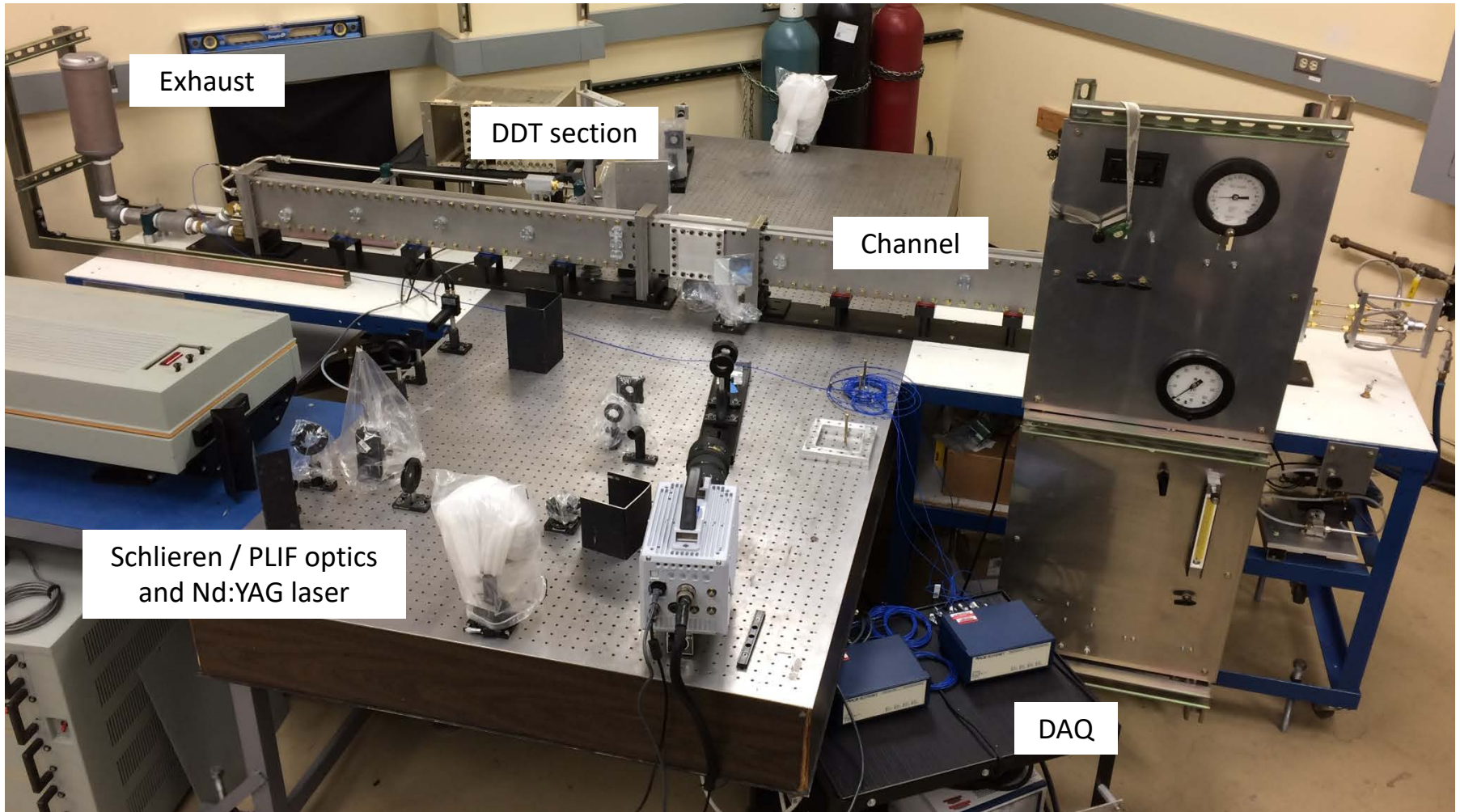

- Image shows all major components of the test facility
- Some components removed for clarity

Detonation channel description

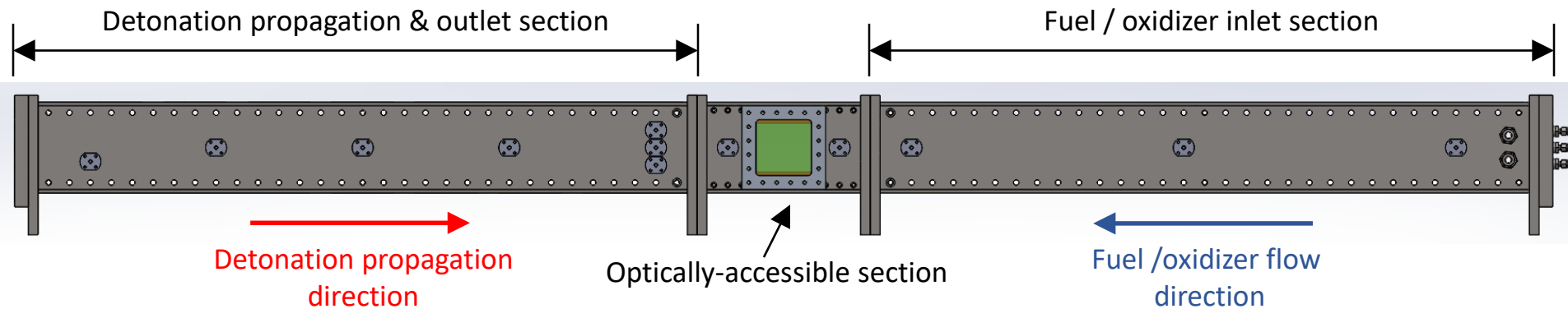

- Parallel test configuration shown
- Channel comprised of three main sections
- All sections bolted together to allow for geometry changes (no welds)
- Cross-section dimensions: 0.75" by 3.5"
- Overall length: ~11 ft.
- Sections are re-arranged to operate the test facility in different configurations

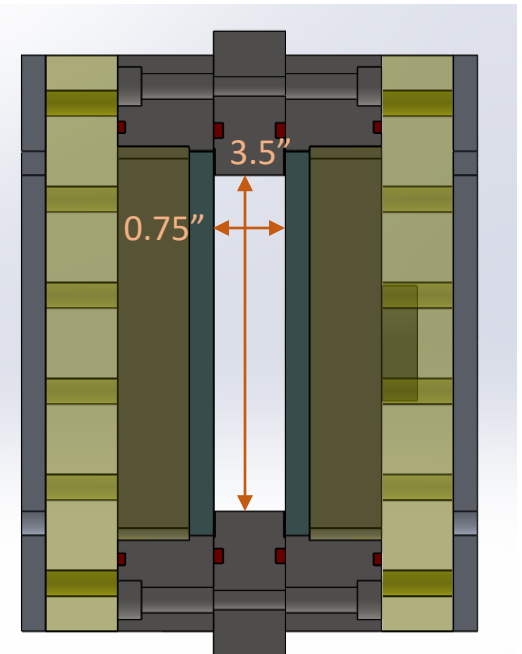

Optically-accessible section cross-section

Detonation channel description

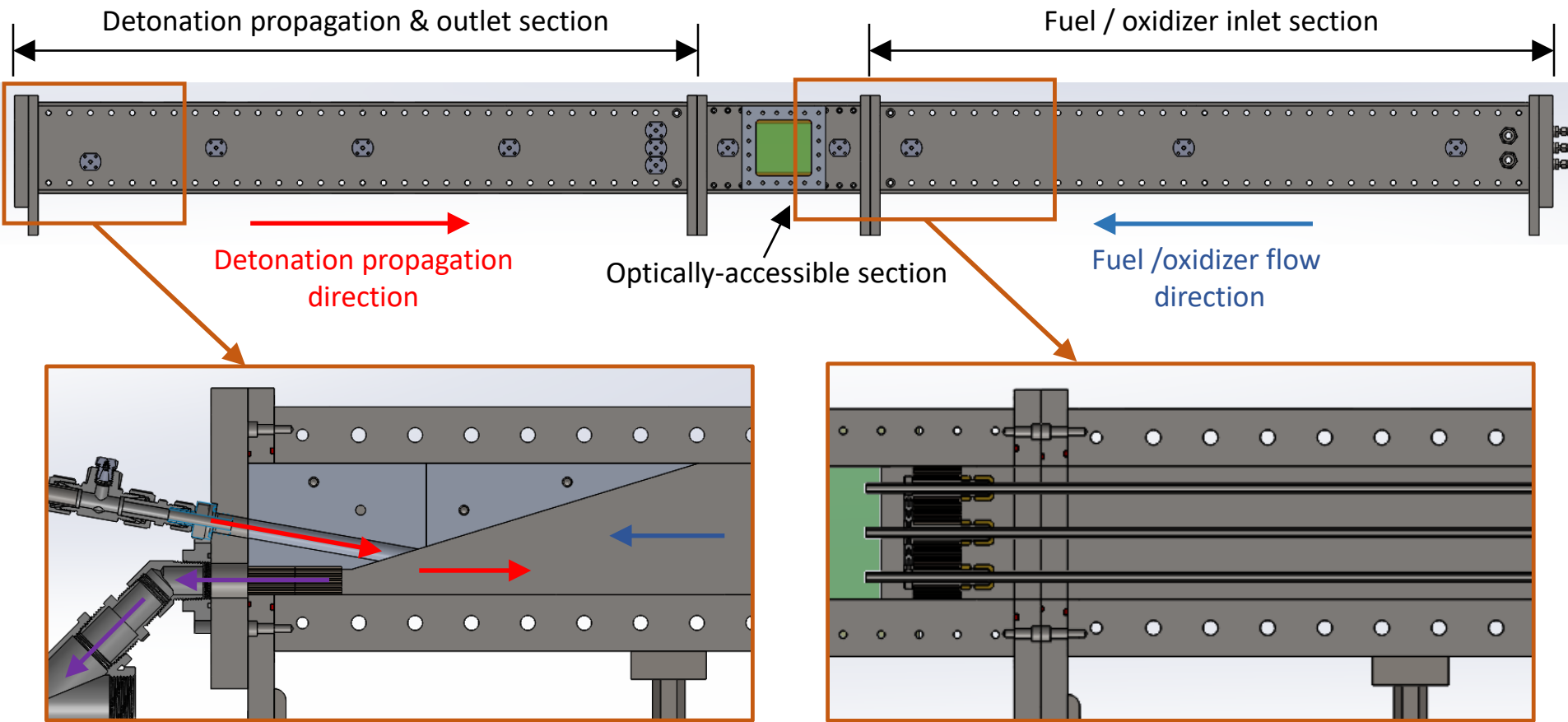

- Detonation initiated in DDT section
- Wave enters channel and expands along incline to prevent detonation wave failure
- Dilution air, water, and constrictions used to dampen detonation exiting combustor
- Location of fuel injection tubes is variable; allows for imaging of different parts of the fuel jet/air mixture without moving the optical window
- Channel can also be operated fully premixed

Channel wall sealing

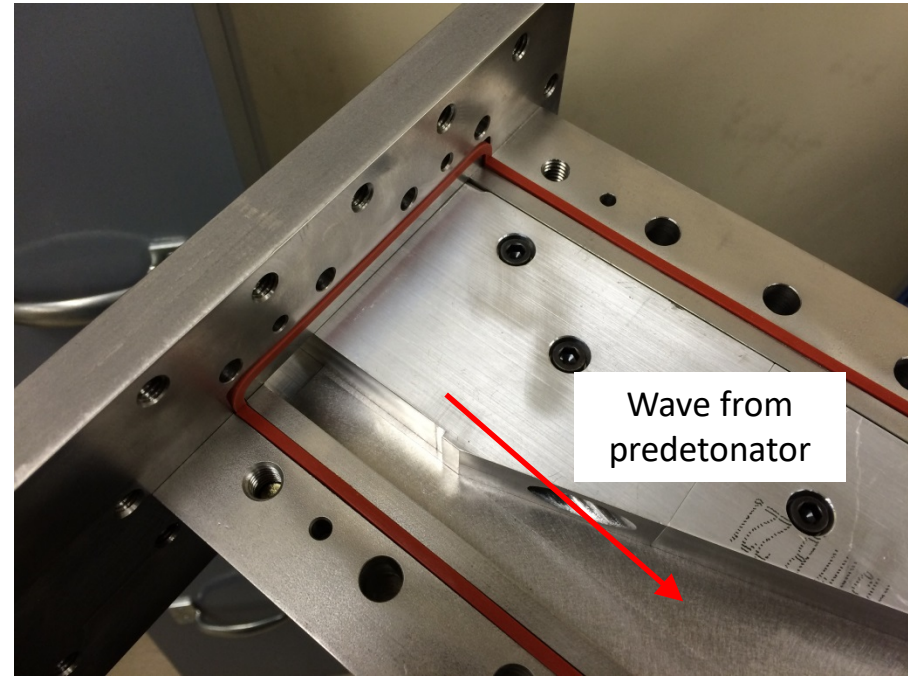
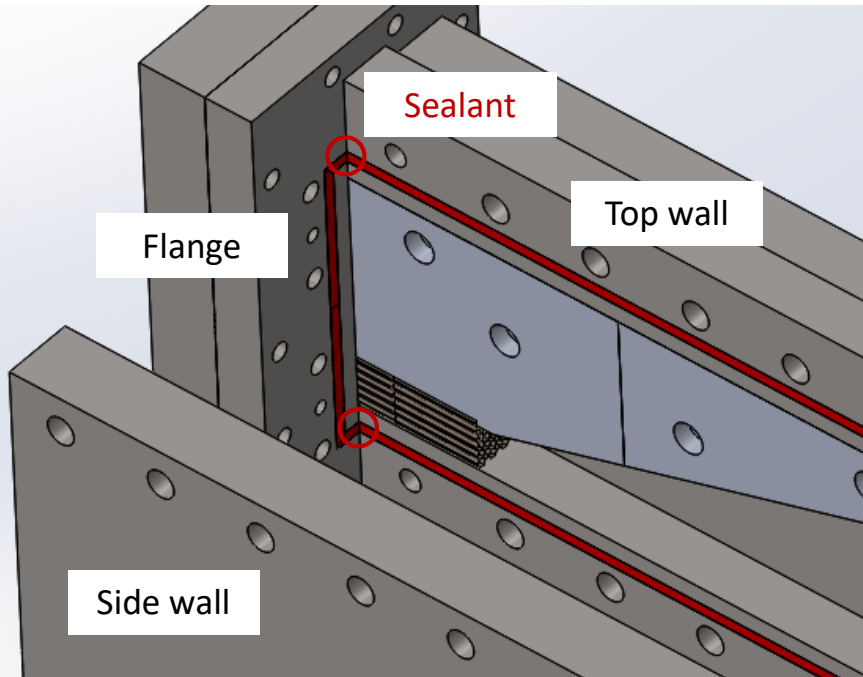

- All channel walls sealed with silicone o-rings and o-ring cord stock
- “3D” o-ring design – silicone sealant used to connect o-rings at flanges
- Allows for relatively easy modification of the channel

Optical access, schlieren, and PLIF systems

Optically-accessible section cross-section

Inner quartz window

Outer acrylic window

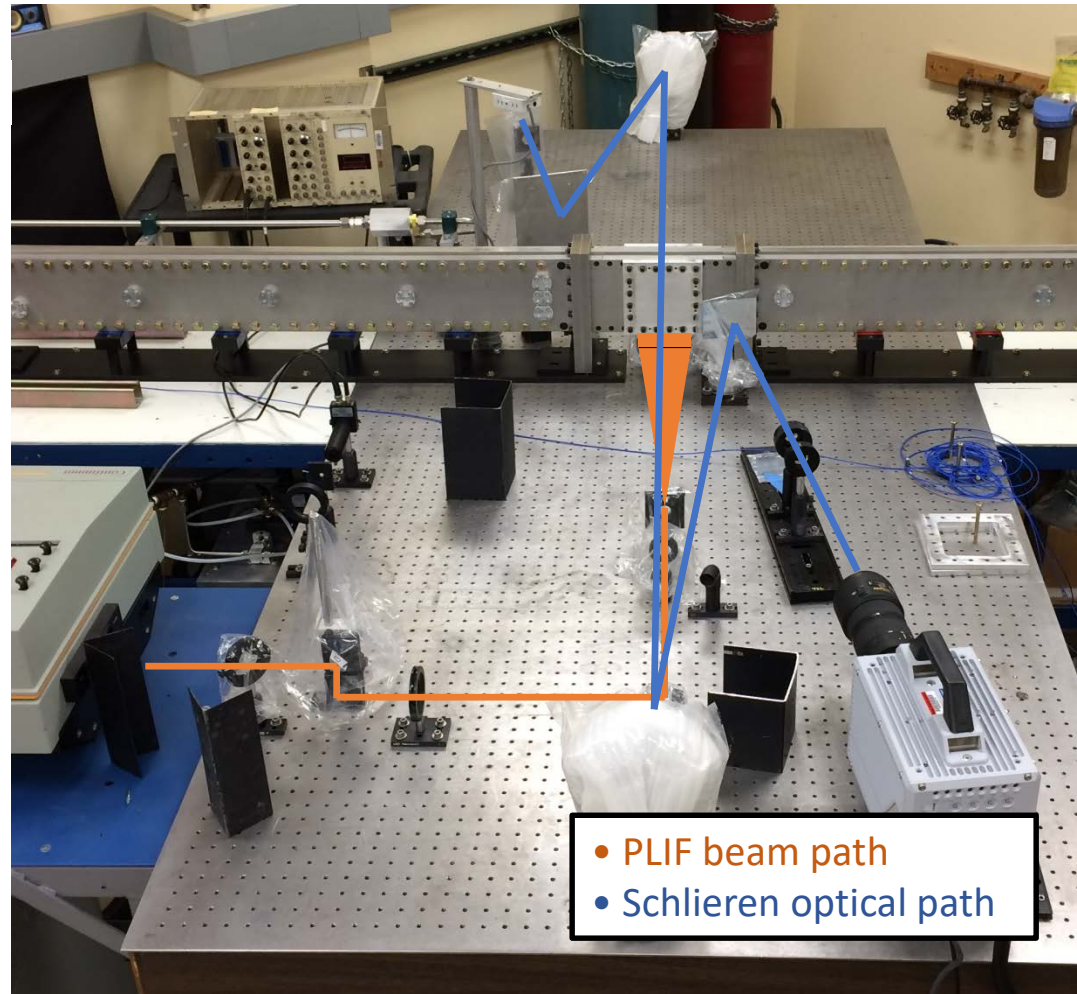
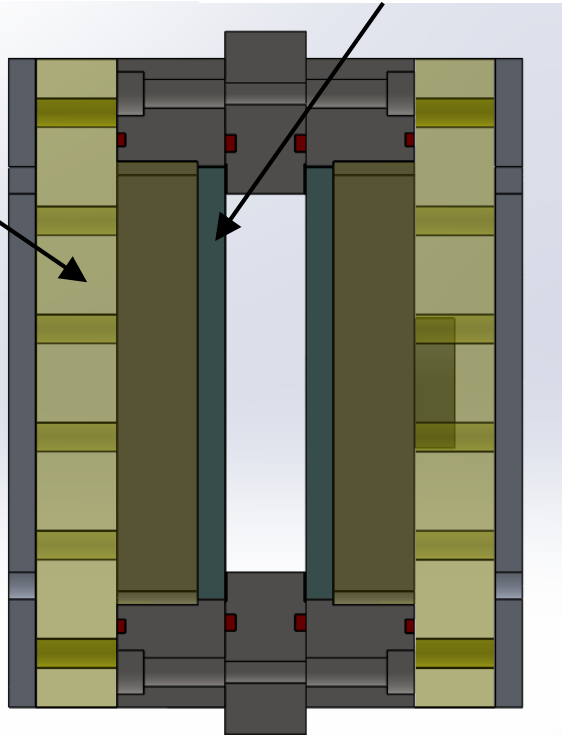

• PLIF beam path
• Schlieren optical path

- Windows allow for complete optical access across the channel height
- Schlieren and PLIF optics aligned on single optics table

Operating conditions / Measurement techniques

Property	Range
Fuel composition	Hydrogen, blends of natural gas and hydrogen
Oxidizer composition	Air, oxygen, and oxygen-enriched air
Global equivalence ratio	Fuel lean through stoichiometric
Initial temperature	20 – 200°C
Initial pressure	1 – 4 atm

- In addition to the optical measurements described on the previous slide, the channel is instrumented with pressure transducers
 - 16 locations for pressure measurements
 - Velocities calculated from pressure measurements
 - Flush mounted with the inner channel wall
 - Used to trigger camera in schlieren system
- DAQ: 12 simultaneously sampled channels (2 to 4 MS/s/channel)

Example pressure profiles and detonation velocity calculation

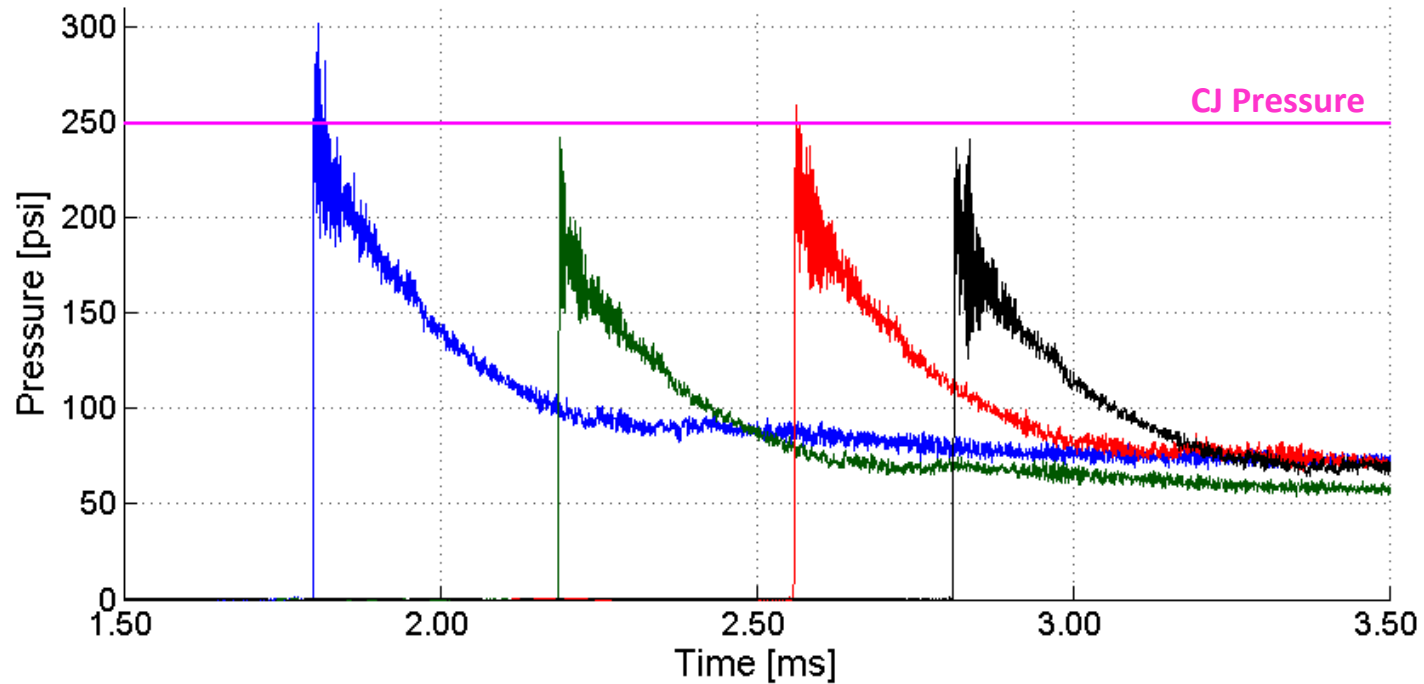
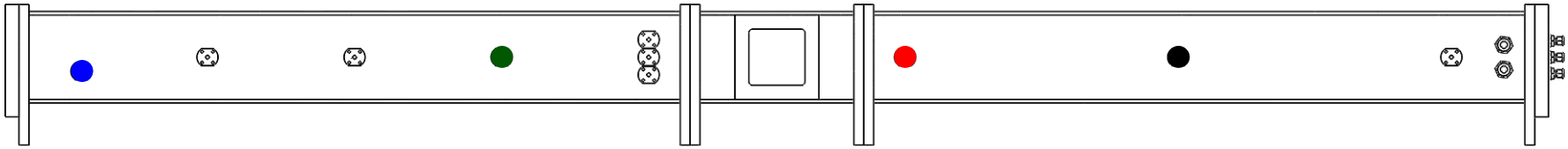

- H₂-air stoichiometric mixture, 16.5 psia initial pressure, 21°C initial temperature
- Time delays calculated using a cross-correlation of the pressure signals
- Calculated velocity: 1921 m/s, ~2.5% below CJ velocity (1971 m/s)

Uniformity of detonation wave at exit of initiation section

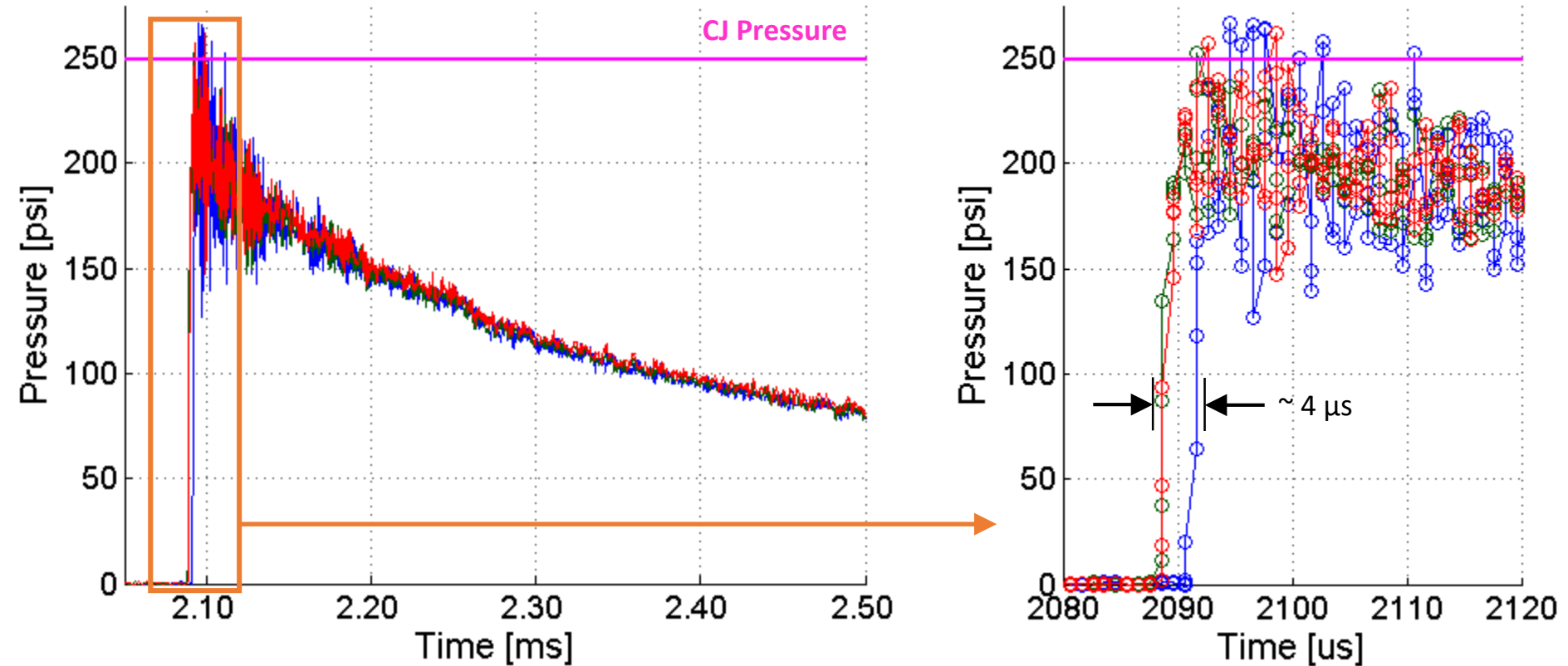
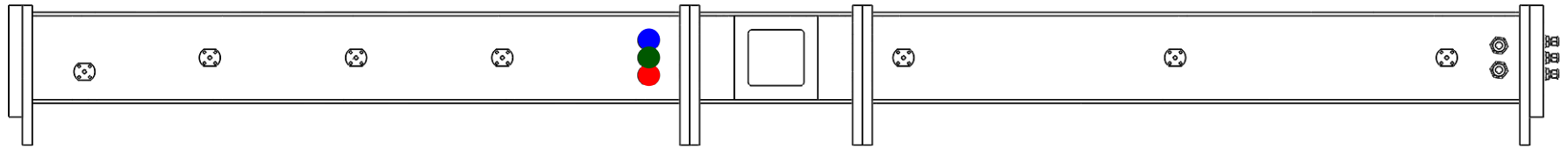

- Three PTs installed at same axial location to measure uniformity of detonation wave
- Leading detonation wave is uniform heading into window test section ($\sim 4 \mu\text{s}$ difference, approximately equal to the travel time across each PT face)

Channel characterization – velocity and peak pressure (1 atm)

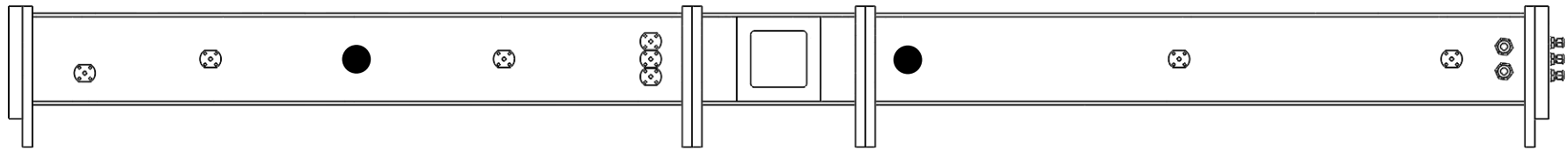

Galloping ← → Stable

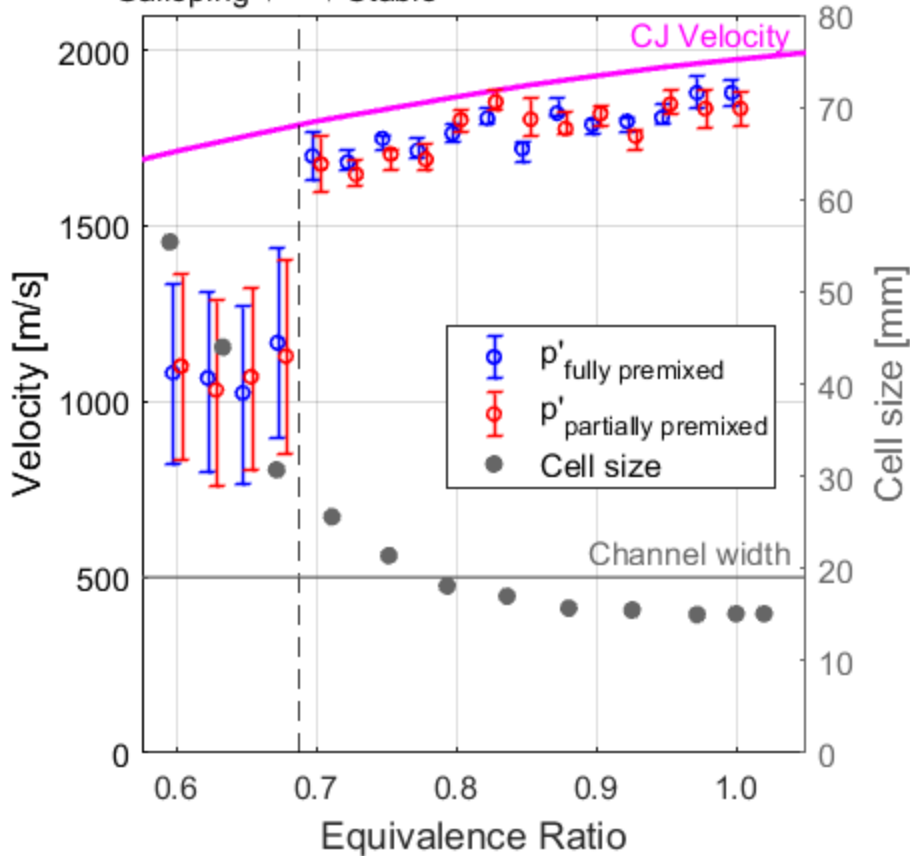

Galloping ← → Stable

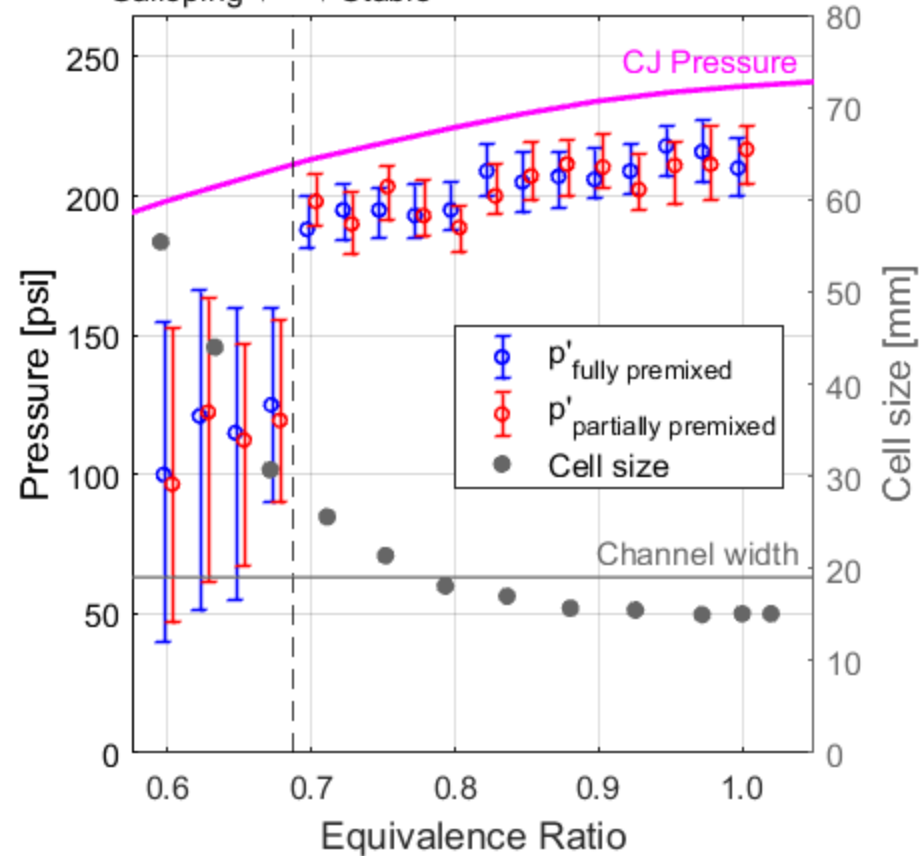

- Ten measurements for each equivalence ratio; error bars show range of value
- Detonation propagation is affected by confinement below $\Phi = 0.7$

Example pressure traces for detonation tests with mean flow

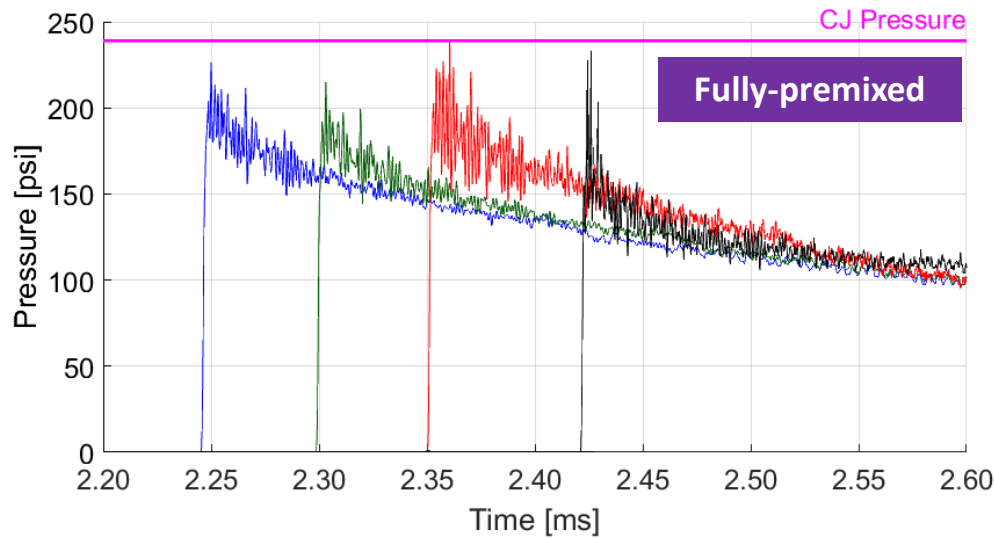

- H₂-air stoichiometric mixture
- 15.1 psia initial pressure
- 21°C initial temperature

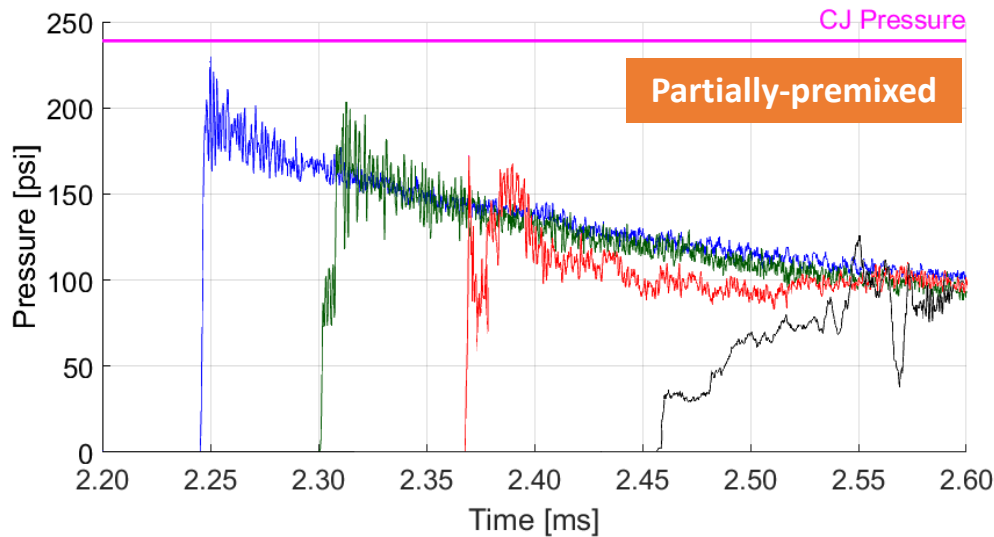
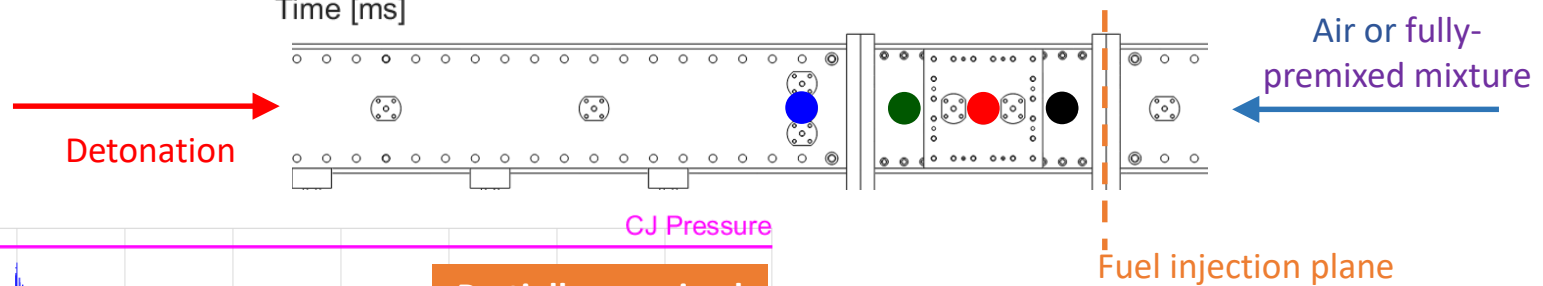

- Two fuel tubes (D = 8 mm)
- $Re_D \approx 11,000$

Detonation peak pressure near fuel injection plane

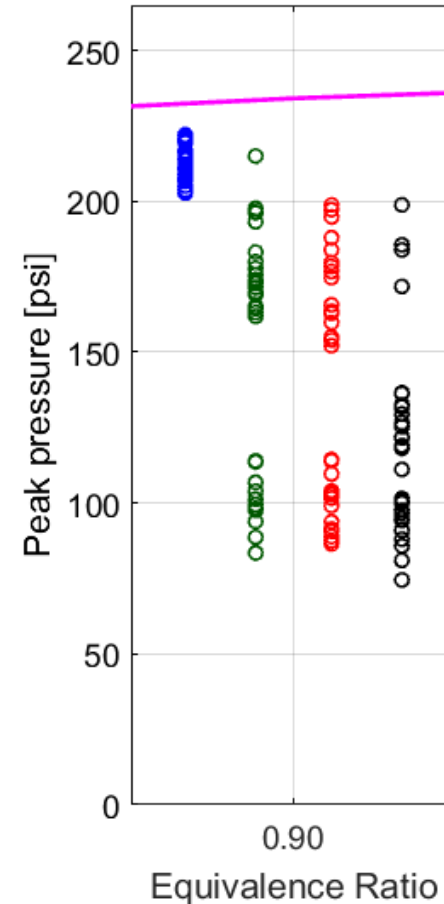
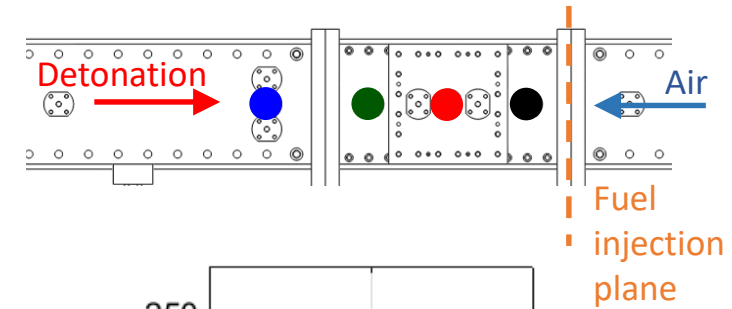
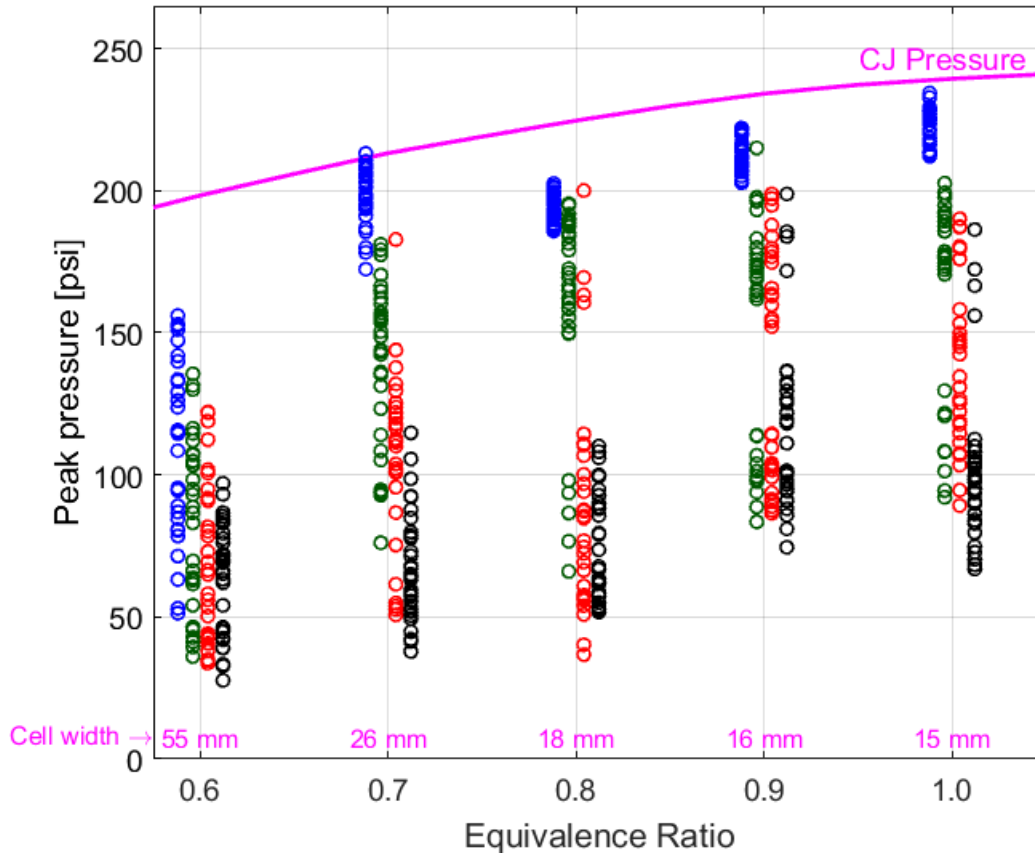

- In general, peak pressure decreases as the detonation approaches the fuel injection plane
- Large variability in peak pressures at identical conditions; wave is significantly affected by upstream conditions

Increased initial pressure measurements – channel characterization

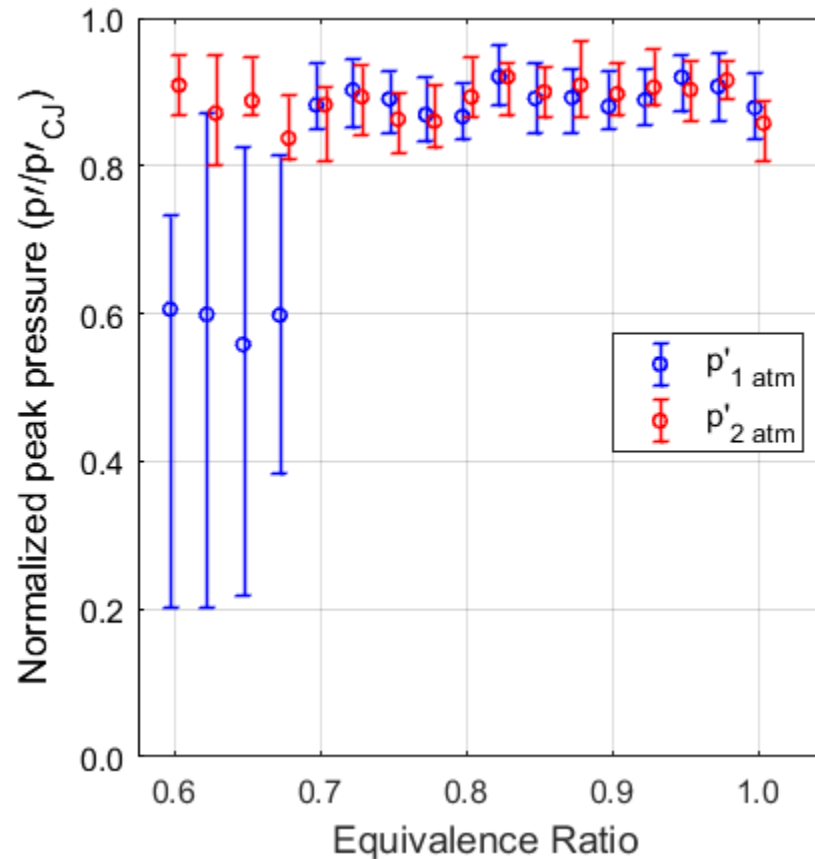

- Ten measurements at each equivalence ratio; error bars show range of measurements
- 1 atm tests shows effect of confinement below $\Phi = 0.7$ (galloping mode); 2 atm tests propagate “steadily” through range tested

Detonation peak pressure near fuel injection plane ($P_i = 1$ and 2 atm)

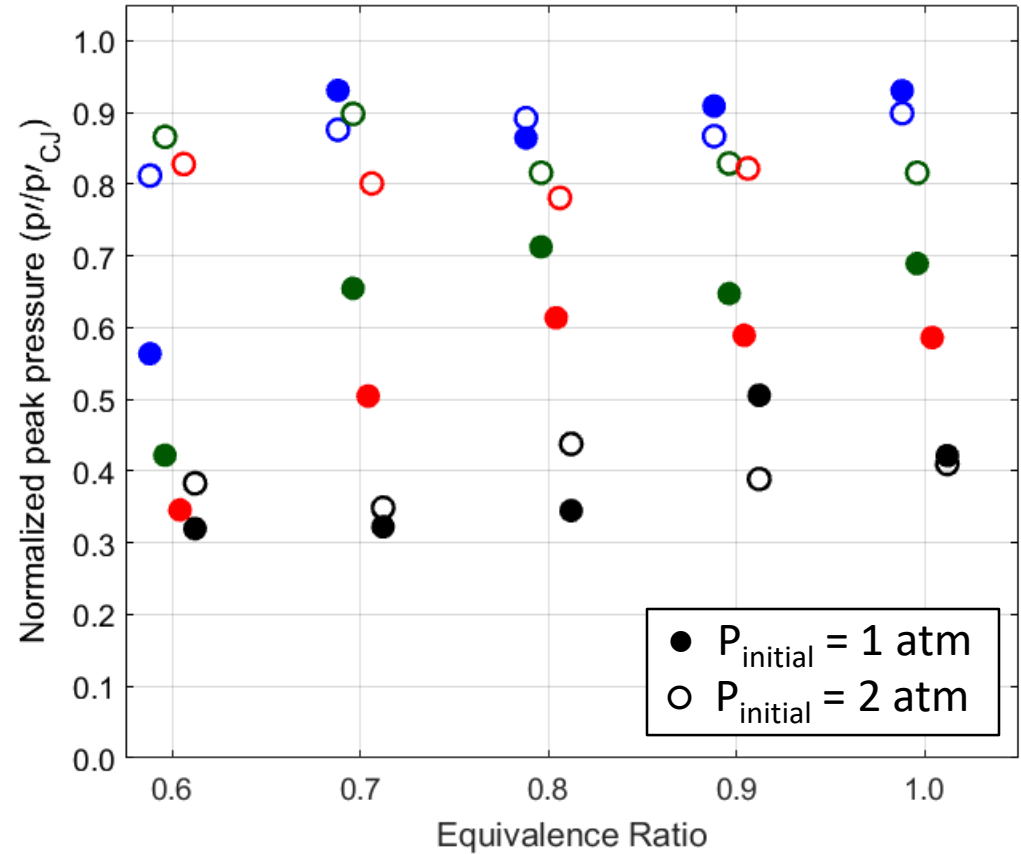
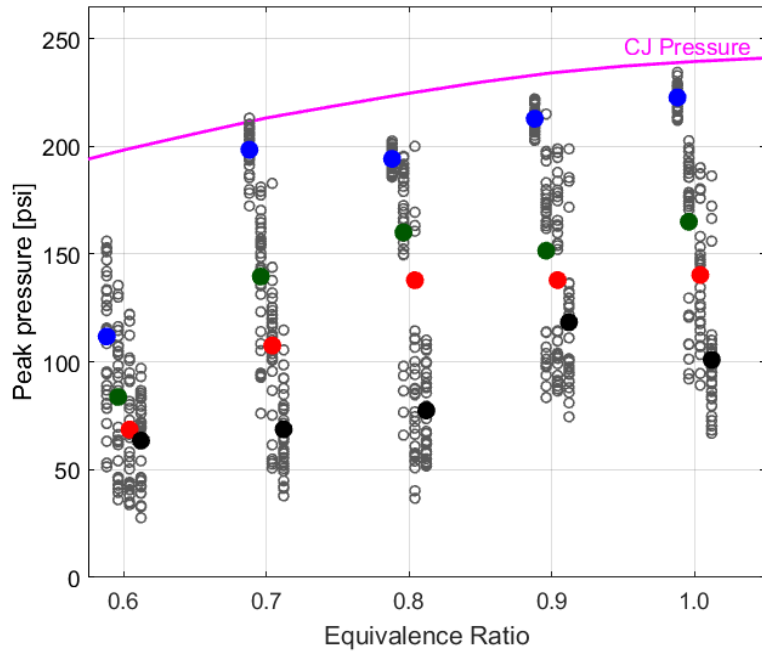

- Co-flow and jet velocities identical for 1 & 2 atm tests
- Thirty cases for each equivalence ratio averaged to show general effect of increasing initial pressure

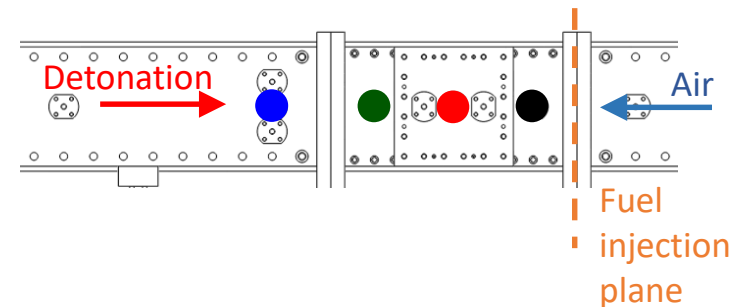

Next steps

- Continue detonation measurements of inhomogeneous mixtures in the parallel test configuration
 - Mixture concentration variations measurements
 - Schlieren imaging of detonation structures
- Measurements of the concentration variation in simulated RDE (perpendicular) configurations
- Will start with configuration shown on right
 - H₂ jets: round holes
 - Air jet: slot
- Variable gap width, H₂ hole diameter, air slot width

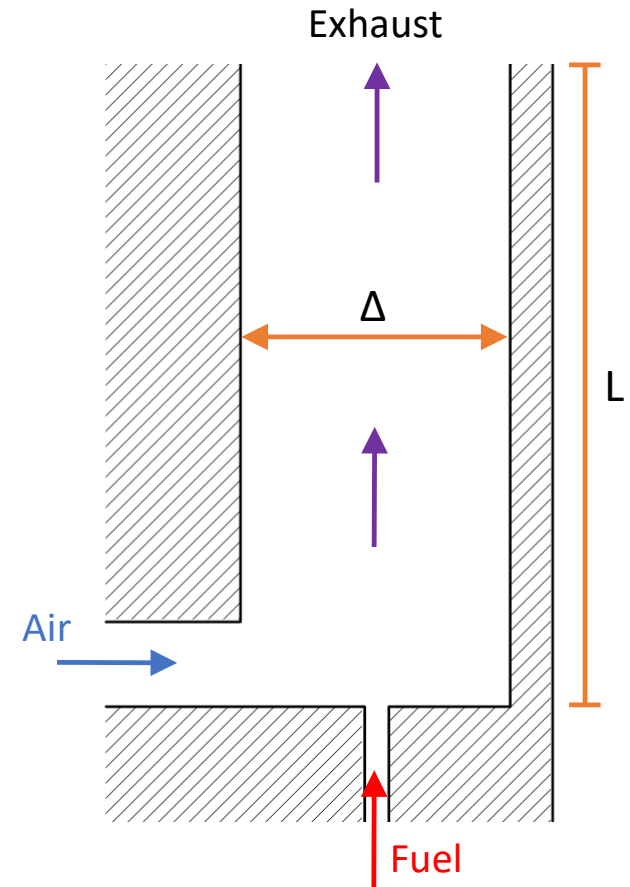

Perpendicular configuration (RDE simulation)

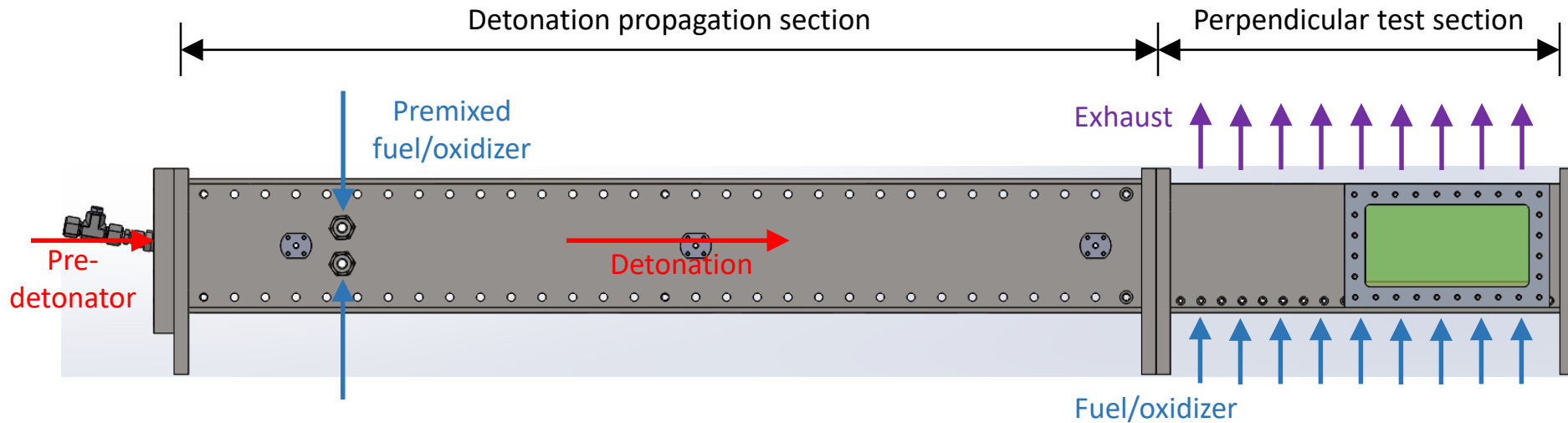

- Perpendicular test section is attached to part of the test channel to simulate an RDE
- Slow flow of fully premixed fuel/oxidizer used to establish planar detonation wave prior to interaction with the high velocity, perpendicular flow in the end section
- Gap width variable between 0.20 and 0.75 in. (discrete increments)

Future work / project goals

- Mixing conditions that result in leading wave separation from the reaction zone
- Effect of mixedness on detonation cell structure and propagation mode (stable, spinning, galloping waves)
 - affects detonation velocity and peak local pressures
- Measure leading wave front angle and detonation wave lift-off height above injection plane in a simulated RDE channel

Thank you!

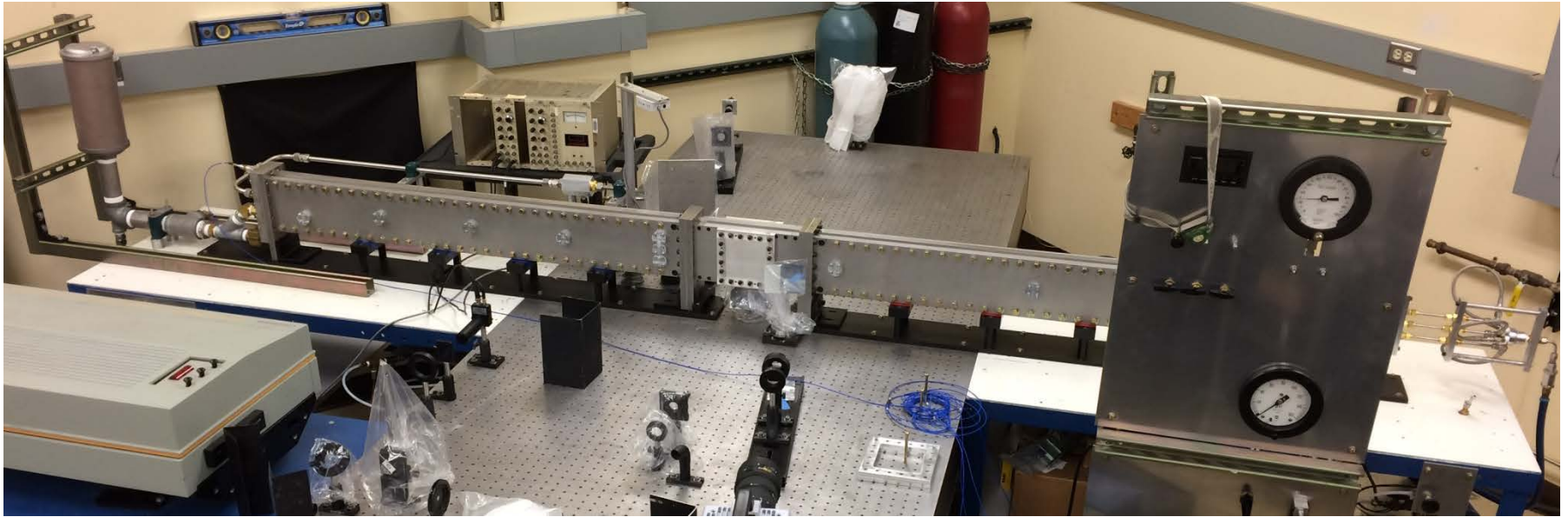

Extra slides

Normalized peak pressure v. axial distance to injection plane

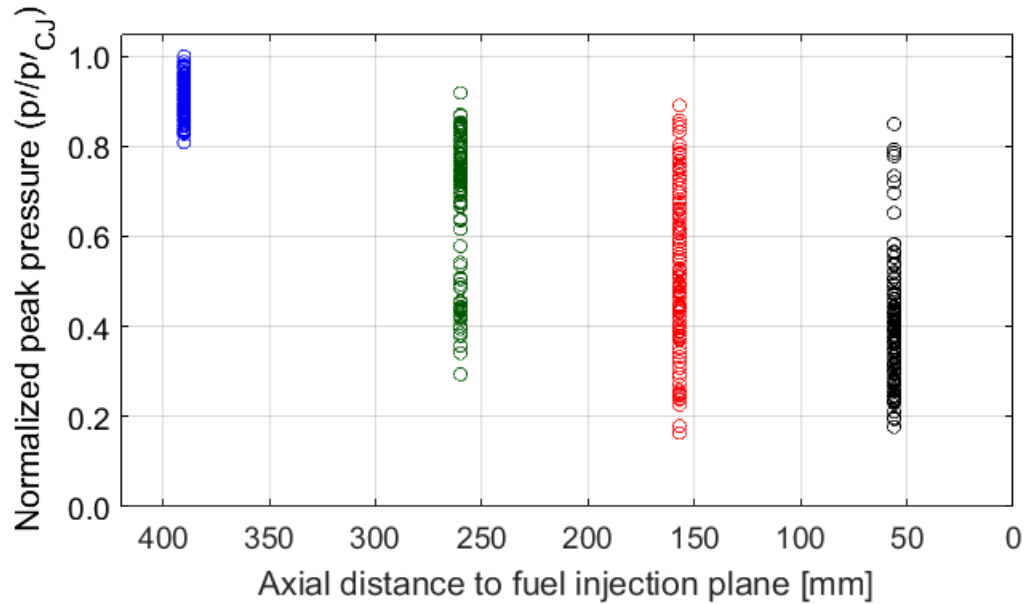
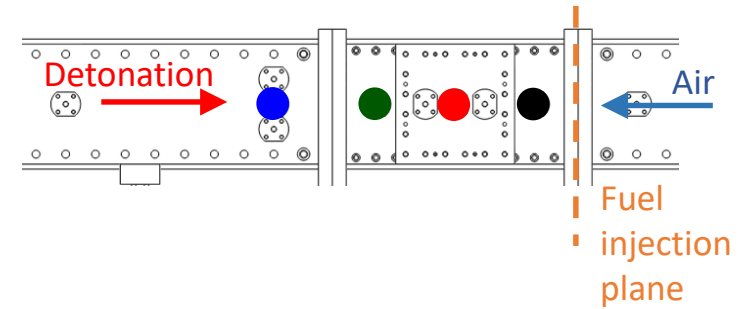

Fuel-oxidizer mixing in an example RDE

- Simulation of H₂-air mixing in the Shank (2012) rotary detonation engine
- Authors found low fuel penetration into the air cross-flow near the injection location at baseline condition
- Air mass flux, fuel mass flux, and fuel injection location were varied

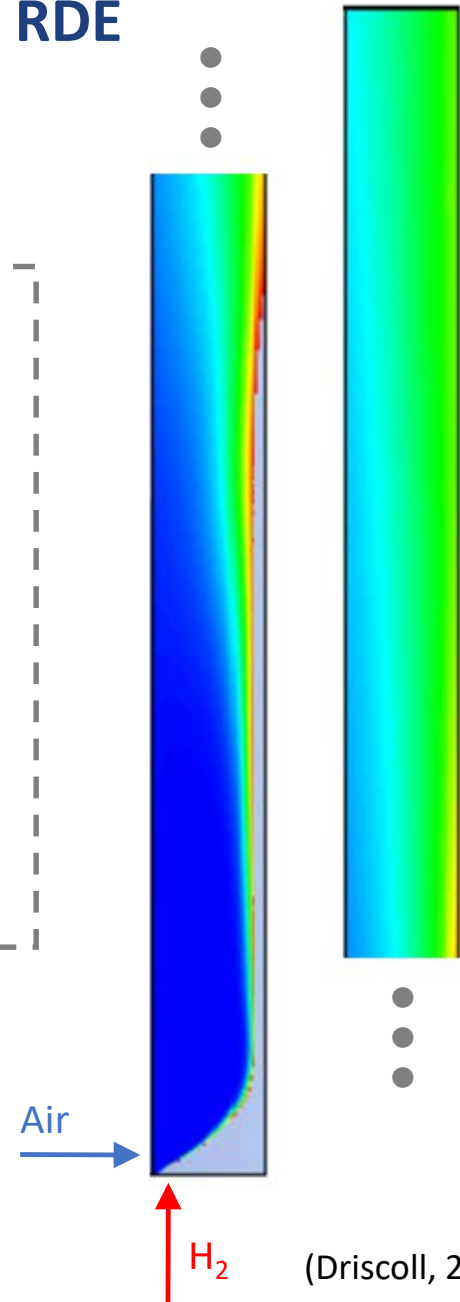
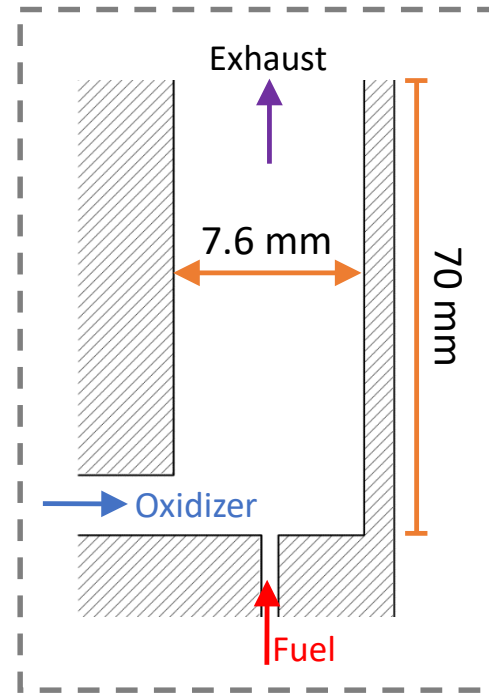

Figure 5: Contours of Equivalence Ratio for Case 1.00_1.0

(Driscoll, 2015)